

Fetal Monitor User's Manual

Contents

1. Preface.....	1
1.1 Introduction.....	1
1.2 Safety Guide.....	1
1.3 It is needed to confirm fetal survival before using the monitor.....	3
1.4 Intended Use.....	3
2. Monitor Installation.....	4
2.1 Unpacking and Checking.....	4
2.2 Power Supply.....	4
2.3 Starting Up.....	5
2.4 Connecting the Probe.....	5
2.5 Checking the Printer.....	5
2.6 Turning off the Monitor.....	5
2.6.1 Automatic Power off.....	5
2.6.2 Manual Power off.....	5
3. Monitor Overview.....	6
3.1 Monitor Overview.....	6
3.2 Front View.....	6
3.3 Operation and Functions of Keys.....	7
3.4 External Interface.....	8
4. Monitor Display Interface.....	9
4.1 Overview.....	9
4.2 Description of Main Interface.....	9
4.3 Description of Menu Settings Interface.....	11
4.3.1 Main menu:.....	11
4.3.2 Date.....	12
4.3.3 System.....	13
4.3.4 Print.....	13
4.3.5 Alarm Setup.....	14
4.3.6 Color.....	14
4.3.7 Maintenance.....	15
4.3.8 Fetal Param.....	15
4.3.9 Pregnant Woman Info.....	16
4.3.10Rating.....	16
4.4 Backing Operation:.....	16
5. FHR Monitoring.....	17
5.1 Misidentifying MHR as FHR.....	17
5.2 Introduction.....	17
5.3 FHR Setting.....	18
5.4 FHR Monitoring.....	18
5.4.1 FHR Signal Acquisition Methods and Steps:.....	18
5.4.2 Single Fetus Monitoring.....	19
5.4.3 Twins Monitoring.....	19
5.5 Common Symptoms of Fetal Monitoring.....	19
5.6 Cleaning and Maintenance.....	20

Contents

6. Uterine Contraction Pressure Monitoring.....	21
6.1 Introduction.....	21
6.2 TOCO Settings.....	21
6.3 TOCO Monitoring.....	21
7. Fetal Movement Monitoring and Fetus Wake-up.....	23
7.1 Introduction.....	23
7.2 Fetal Movement Monitoring.....	23
7.3 Fetus Wake-up.....	24
8. Alarm.....	26
8.1 Alarm Category.....	26
8.2 Alarm Level.....	26
8.3 Alarm Indication.....	26
9. Printing.....	28
9.1 Installing Printing Paper.....	28
9.2 Print Settings.....	28
9.3 Print.....	29
9.4 Cleaning the Printing Head.....	29
10. Rating.....	30
10.1 Description.....	30
10.2 Operation.....	30
10.3 Alarm.....	33
Appendix 1: Troubleshooting.....	34
Appendix 2: Specifications.....	35
Accessories.....	36

1. Preface

Introduction

Safety Guide

Recommended clinical application

1.1 Introduction

Welcome to use the Fetus / Pregnant Woman / Patient Multi-parameter Monitor (referred to as the Monitor)!

This Manual will describe the performance indicators, use and maintenance method of the Fetus / Pregnant Woman / Patient Multi-parameter Monitor in details, and is intended for the personnel that are familiar with the parameters and have experience in the use of the Monitor.

Before using this Monitor, please read the User's Manual carefully in order to use the monitor properly, make the device reach its performance indicators and use under the required safety standards.

This User's Manual is provided together with the Monitor, and should be placed near the Monitor for easy reference.

1.2 Safety Guide

BF-typed mobile device.



indicates BF application.

BF protection indicates that patient connection should comply with the requirements of IEC60601-1 on allowable leakage current and dielectric strength.

The waterproof rating of the ultrasonic probe is IPX1.

Instructions for Operation Safety

To avoid potential injury, be sure to abide by the following safety instructions while operating the Monitor.

Warning: Do not rely solely on the alarm system of the Monitor when monitoring the patient. If the alarm limit is set too low or alarm sound is turned off, it may hurt the patient. The most reliable method is that the health care professionals closely monitor and properly use the Monitor. The alarm functions of the Monitor must be periodically verified. When several devices are simultaneously used on the same patient, the leakage current may be superposed. Before interconnection, it is recommended that ask qualified professional to test the leakage current to ensure that the leakage current is in the safe range, that is, won't cause any harm to the patient, the operator and the surrounding environment. If you still have questions, please consult the manufacturer for the correct use. Before using this Monitor, the operator must verify that the Monitor is in proper working condition and operating environment. When use high-frequency electric knife, the patient leads and wires should be placed away from the surgery, where the cable is away from other devices, in order to reduce the risk of burning caused by high-frequency electric knife if the neutral connection is poor. Regularly check if the reusable accessories and the sensors are damaged, if the cables are connected reliably, replace if necessary, and dispose the damaged accessories properly as medical waste.

Warning: Do not use the instrument in the presence of flammable gases such as anesthetic agents, or it may cause an explosion.

Warning: Don't throw the battery into fire, or it may cause an explosion.

Warning: Don't touch the signal input or signal output connectors and patient at the same time

Warning: The device is used on one patient at one time.

Warning:This fetal monitor is not protective from quiver, do not be used near electrosurgery devices (including high frequency operation devices), or in proceeding of MRI inspection to use this fetal monitor, to avoid dangerous for operators or patients.

Caution: This instrument must be maintained by qualified engineers.

Caution: This instrument is designed to work continuously, water drop proof type, pay attention to avoid to be splashed.

Caution: Keep this instrument clean and avoid vibrating.

Caution: No high temperature disinfection, electron beam or γ -ray sterilization.

Caution: Electromagnetic interference – ensure the operating environment of the instrument away from strong interference, such as wireless transmitters, mobile phones or other interference.

Caution: Before using the instrument, please check if there is any damage of equipment that may affect the patient's safe or the instrument performance. The recommended check period is every one month or shorter. If an obvious damage is found, it should be solved before use.

Caution: The following safety check is done by the authorized person, normally one time per two years or according to test regulation by the public organization.

◇ Check whether there are damages in the mechanical and functions.

◇ Check whether the relative safety label is easy to identify.

◇ Check whether the function is the same as described in the user manual.

Caution: After the effective life of this instrument, Please send it back to the manufacturer according to local rules for recycling.

Caution: Disposal the battery properly according to local rules after the capability of battery run out.

Caution: If this instrument is not in use for a long period of time, remove the battery in time.

Caution: The battery should be stored in a cool and dry environment.

Caution: When store battery, please don't mix it with metal objects to avoid short-circuit accident.

Caution: We recommend that exposure to ultrasound should be kept As Low As Reasonably Achievable. This is considered to be good practice and should be observed at all times.

Caution: Don't use this instrument immediately when it is transferred from a cold environment to a warm and moisture place.

Caution: To ensure electric installation safety, the environment shall be reasonably dust free, without corrosive or combustible gas, or extreme temperature or humidity.

Caution: Please stop operating if this instrument is splashed or has water drops.

Caution: Although the instrument is robust and designed to withstand the clinical use, the unit does contain delicate components and should be treated with care. This applies especially to the transducers which should not be dropped or knocked.

Caution: The use of water based gel supplied by certificated suppliers is strongly recommended. Oil based gels can damage the transducer and must not be used. The use of oil based gels will invalidate your warranty.

Caution: Excess gel should always be wiped off after use. The transducer faceplate, transducer body and main unit can be cleaned with a damp cloth impregnated with a mild disinfectant or detergent.

Caution: A soft cloth dampened with sodium hypochlorite 100ppm may be used for cleaning and

disinfection.

Caution: The main unit, transducers and other accessories can't be disinfected by steam.

Caution: TOCO transducer is non-waterproof type, don't use Gel and avoid any liquids into it.

Caution: The power wire should be inserted into the socket with three wires, the ground wire mustn't be removed. Don't use the socket with bad connection.

Caution: After use, do not wire the transducer cable together with the transducers to avoid damage.

Caution: Do not turn off the volume during monitoring, it is very important to monitor fetal heart sound.

Caution: The accuracy of FHR is decided by machine itself and cannot be adjusted. If you are suspicious of accuracy of the result, you can verify it through other devices like a stethoscope, or you can contact local distributors or manufacturers for help.

1.3 It is needed to confirm fetal survival before using the monitor.

Current technology cannot distinguish fetal heart rate (FHR) signal source from maternal heart rate (MHR) signal sources in all circumstances. Therefore, before the monitoring, you must use a different method to confirm that the fetus is still alive, such as palpation fetal movement, a Fetal stethoscope or a pinard. If you can't hear the fetal heart sound, or fail to address the fetal movements, you will need to use the obstetric ultrasound to confirm fetal survival, and confirm that the fetus is the guardianship of the signal source.

Should have known:

- MHR traces and FHR traces can be rendered extremely similar characteristics, as well as acceleration and deceleration.

- Don't just rely on movement of the trace feature to identify sources of the fetal heart rate. There are only traces of the fetus fetal movement on curve (FM) marks does not always guarantee that the fetus is still alive. Deceased fetus also moves the body and lead to a mark of monitor fetal movements.

Here are a few examples, indicates how the MHR will be identified as FHR by error.

- When Ultrasonic transducer is used: you can pick up signals to the mother source, such as a mother's heart, aorta or great vessels of other beats. When the MHR higher than normal (especially above 100bpm), it is possible to identify where the error occurred.

- When enabling AFM curves (AFM):

the following may be causing fetal death and still appear in the context of FM tags:

- △dead fetus in utero during exercise or after exercise.

- △During and after manual palpation of fetal movements (especially if the pressure is too large), the dead fetus will be moving.

- △Movement of the ultrasonic transducer.

- △Ultrasonic transducer detects the motion signal source, such as its main artery.

To reduce the possibility of confusion between MHR and FHR, also recommended that monitoring of maternal and fetal heart rate simultaneously.

1.4 Intended Use

The Fetus Monitor applies to external monitoring.

- Antenatal monitoring in the hospitals
- Antenatal monitoring within the family or community
- Examination before hospitalization

2. Monitor Installation

Unpacking and checking

Power supply

Starting up

Connecting the probe

Checking the printer

[Note]

To ensure normal working of the Monitor, please read this chapter and 1.2 Safety Guide before using, and install as required.

2.1 Unpacking and Checking

Unpack and take out the Monitor and accessories carefully, and keep the packing materials for future transport or storage. Please check the Monitor, accessories and provided documents according to the Packing List.

- Master unit
- Power cord
- Three-in-one probe (ultrasonic probe U/S, uterine contraction probe TOCO and an event marker for pregnant woman)
- Second ultrasonic probe (optional)
- Oximeter probe (SpO₂) for pregnant women, air cell, ECG lead and body temperature probe (optional) for noninvasive blood pressure measurement of pregnant women
- Printing paper
- Coupling agent (optional)
- Certificate
- Warranty Card
- User's Manual
- Packing List

✘ Check for any mechanical damage.

✘ Check all exposed wires and connect the accessories.

For installation, keep at least 2 inches (5 cm) space around the Monitor to ensure air circulation. The environment for the Monitor should avoid vibration, dust, corrosive or explosive gases, extreme temperature and moisture. If you have any questions, please contact our Sales Department or the dealer.

2.2 Power Supply

2.2.1 AC Power

To connect the AC power cord:

✘ Make sure the AC power supply meets the following specifications: AC 100~240V, 50/60Hz

✘ Use the provided power cord. Plug the power cord into the power connector of the Monitor, and plug the other end into a grounded three-wire power outlet.

[Note]

Connect the power cord to the dedicated outlet in the hospital.

✘ Turn the power switch to “-”.

2.2.2 Battery Powered

When the AC power is cut off, the Monitor will be powered by the built-in batteries. Before using, please charge the batteries. When the Monitor is connected to AC power, the charging starts automatically, and doesn't require additional charger. To ensure the batteries are fully charged, we recommend that the users connect this Monitor to an AC power source even when the Monitor isn't used.

The new fully charged batteries can maintain monitor work, while using the printer will accelerate the power dissipation. When the batteries are running low, the battery symbol in the lower left corner of the screen will flash, prompting the user to charge as soon as possible.

Warning:

Even if the instrument is not working, the batteries will gradually discharge. If the Monitor will be stored for long-term, please keep the Monitor fully charged. Check the battery status at least once a month and recharge.

2.3 Starting Up

Press and hold the Power button for about 2 seconds to enter the starting up state, and the alarm lamp is lit in green. After three seconds, the system self-tests successfully and enters the main screen, and then the user can start operation.

[Note]

If fatal error is found during self-test, the system will alarm.

[Note]

Check all available monitoring functions to ensure that the Monitor functions properly.

Warning:

If the monitor function has any signs of damage or an error message, do not use this Monitor, and contact the biomedical engineer of the hospital or the maintenance engineer of the company.

2.4 Connecting the Probe

Connect the desired probe to the Monitor and the monitoring position of the patient.

[Note]

For the correct connection of probes and related requirements, see Chapter 5-7.

2.5 Checking the Printer

Check if the paper outlet in the front side of the Monitor has printer paper. If not, see Chapter 9 Printing.

2.6 Turning off the Monitor

2.6.1 Automatic Power off

Select “Turn off the Monitor” in the System Settings interface to set the time of automatic power off: 0 indicates that the function is invalid. Other values indicate that if the time without signal exceeds the values, the system will automatically shut down. The time of automatic power off can be set up to 240min. When the set time of automatic power off is up, the interface prompts: turn off automatically.

2.6.2 Manual Power off

Press and hold the Power button for 2 seconds, the screen displays “Power off”, and then turns off the Monitor.

3. Monitor Overview

Monitor Overview

Front View

Operation and Functions of Keys

External Interfaces

3.1 Monitor Overview

Environmental Requirements

Temperature

Operating: +5°C ~ +40°C

Transport and storage: -10°C ~ +55°C

Humidity

Operating: < 85%

Atmospheric pressure: 86kPa ~ 106kPa

Transport and storage: < 93%

Atmospheric pressure: 86kPa ~ 106kPa

Power Requirements

Supply voltage: AC100-240V, 50/60HZ

Max Power: $P_{max}=45VA$

Battery: 14.8V lithium battery

Do not use beyond the specified environmental requirements and power requirements, otherwise the Monitor may not work properly.

This Monitor applies to the bedside monitoring of fetus. It integrates the parameter measurement, display and record output, compact, lightweight and easy to use. Its high-resolution display interface can clearly show the waveforms and all monitoring parameters.

3.2 Front View

The front panel of the Monitor is shown in Fig. 3-1. It has a friendly interface, and all the operations are available through the buttons and encoder disk on the front panel (①~⑧ shown in Fig. 3-1). For more information, see 3.3 Operation and Functions of Keys.

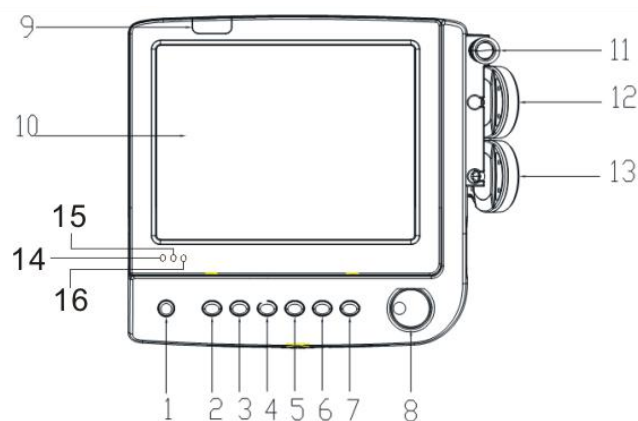

Picture 3-1 Front view

- ①Power ②NIBP start/stop ③Freeze ④Volume-Down ⑤Volume-Up
⑥Printing ⑦TOCO Reset ⑧Encoder ⑨Indicator Lamp ⑩TFT LCD
⑪⑫⑬: Transducer Holder
⑭AC indicator lamp ⑮Charging indicator lamp
⑯indicator lamp when support by battery

3.3 Operation and Functions of Keys

1. Power button

Press and hold this button for about 2 seconds to turn on the Monitor, and press and hold it again for 2 seconds to turn off the Monitor.

In monitoring state, press this button once to refresh the display interface and generate a number for the pregnant women, and the fetal movement counting is reset.

2. Blood pressure measuring button (inaction)

3. Freeze button

Press this button once to freeze the system, and the main interface displays “Frozen”; press it again to unfreeze and restore real-time scanning state.

4. VOL- button

In monitoring state, press this button in the main interface to turn down the speaker volume.

In freezing state, press this button to play the stored records reversely.

5. VOL+ button

In monitoring state, press this button in the main interface to turn up the speaker volume.

In freezing state, press this button to play the stored records forwardly.

6. Print button

After installing the printing paper, press this button to enter the real-time printing status, and press it again to stop printing.

In freezing state, you can print the currently displayed monitoring records and press it again to stop printing.

7. UC Reset button

Press this button once and the displayed pressure is reset to the set value.

During menu setting, press this button again to return to the monitoring screen.

8. Encoder disk

In monitoring state, rotate the encoder disk, press the encoder disk to confirm when the selected area displays a blue frame, and then enter the appropriate settings.

In freezing state, rotate the encoder disk to turn pages of monitoring records.

9. Indicator

Under normal conditions, the indicator is green; in monitoring state, it flashes with the fetal heart rate; when the heart rate is within the safe range, the indicator is green; when the heart rate exceeds the limit and alarms, the indicator color depends on the alarm level.

10. Display

A 12.1-inch TFT display shows waveforms, menus, alarms and physiological measurement parameters.

11. Probe holder: used to hold the probe.

12. AC Indicator

When this indicator is green, the Monitor is connected to the.

13. Charging Indicator

When external power supply is connected, this indicator is orange, indicating that the batteries are being charged; after charging is completed, the indicator goes out.

14. Battery status indicator

When this indicator is green, the Monitor is powered by internal batteries.

3.4 External Interface

In order to facilitate the operation, different interfaces are located in different parts of the Monitor.

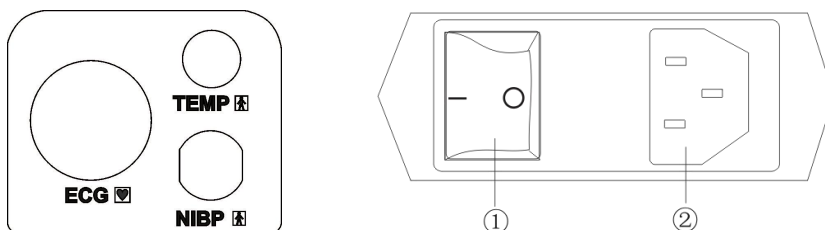

Picture 3-2. Left panel

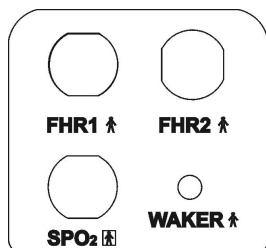

Picture 3-3. Right panel



Picture 3-4 Back panel

Port Introduction

ECG: ECG probe port

TEMP: maternal temperature probe port

NIBP: maternal NIBP cuff input port

①: AC adapter input socket

②: Power switch. Turn on or off the power. I: turn on; O: turn off.

FHR1: port of 3 in 1 transducer

FHR2: the second ultrasound transducer port when doing twin monitoring.

SpO2: port of maternal SpO2 transducer.

WAKER: Fetal acoustic stimulator (FAS) port (option)

NET: network port of central nurse station

USB: retained.

RS232: retained.

4. Monitor Display Interface

Overview

Description of Main Interface

Description of Menu Settings Interface

4.1 Overview

The Fetus/Pregnant Woman/Patient Multi-parameter Monitor has models: three parameters, the monitoring functions of which are:

Function	Model	Three parameters
Interface		Fetus interface
Fetal heart rate (FHR)		Waveform/numeric value
Uterine contraction pressure (TOCO)		Waveform/numeric value
Fetal movement (AFM/MFM)		Waveform (optional) /numeric value

4.2 Description of Main Interface

The display of the Fetus/Pregnant Woman/Patient Multi-parameter Monitor is a 12.1-inch TFT screen, which can display the information about pregnant women, parameter waveform and values, monitoring status, alarm information, and other tips.

The Monitor has fetus interface, as shown in Figure 4-1:

Fetus interface

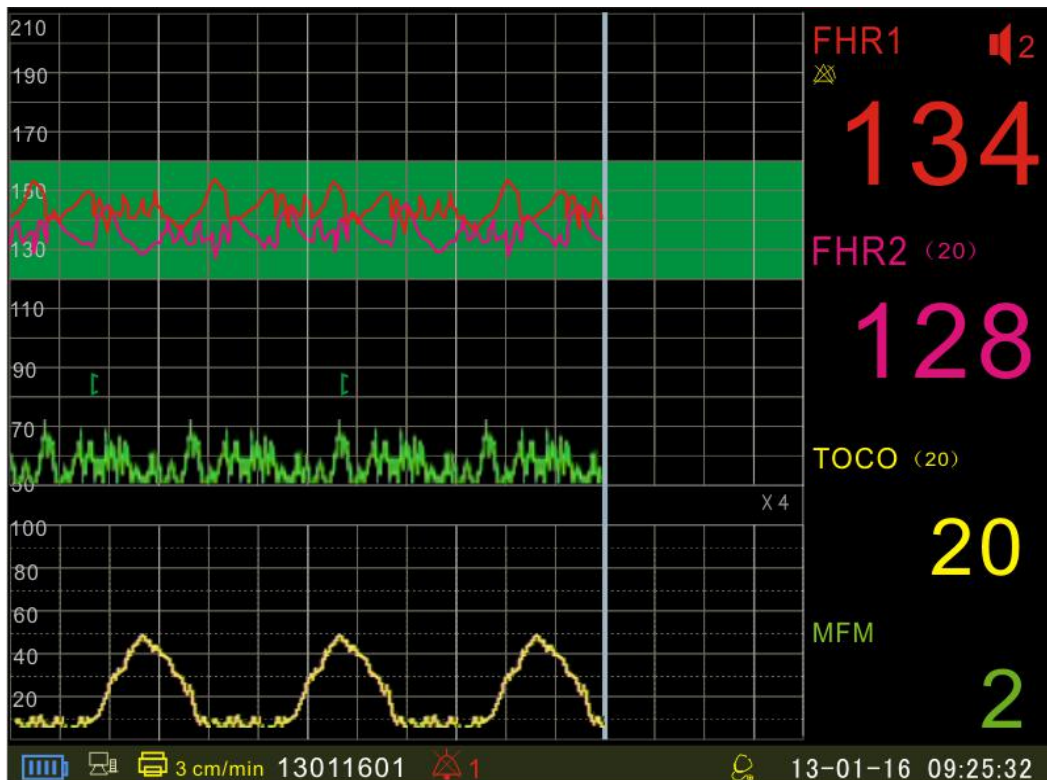
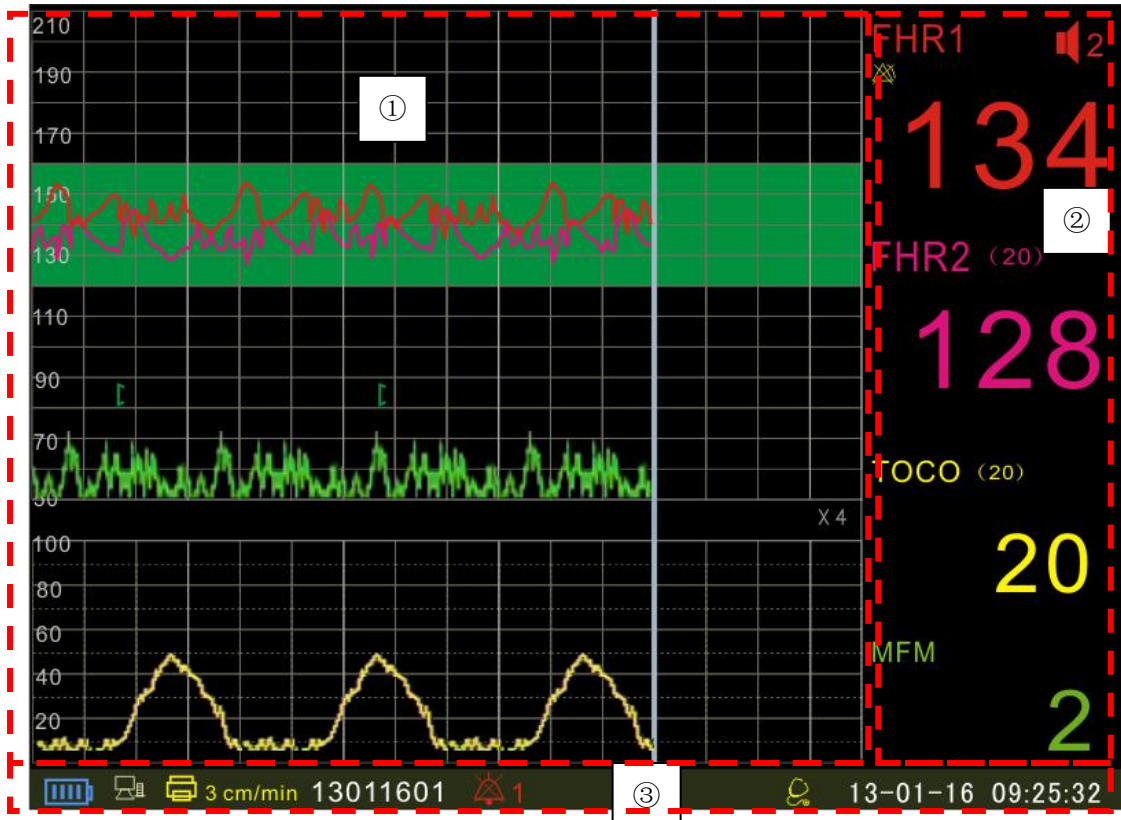

Fig. 4-1 Monitoring Interface Display

The monitoring interface has three sections: ① Waveforms; ② Parameters; ③ Information (as shown in Fig. 4-2)



① Waveforms

The fetus interface / six-parameter interface: Waveforms from top to bottom are: FHR waveform (shown as two FHR waveforms for twins, the interval between the two waveforms is determined by the twin separation value set by the system), uterine contraction pressure waveform, and fetal movement waveform (the user can choose to display or close the waveform as required);

Maternal-fetal interface: the waveforms from top to bottom are: ECG waveform, respiration waveform, and blood oxygen waveform.

② Parameters

The parameters section is in the right of the screen:

1) Fetal heart rate (FHR)

Fetal heart beats per minute (Unit: bpm)



Alarm off; only displayed when the alarm is turned off.



Speaker volume indication in eight levels (0-7); when the system displays, you can adjust the volume through the Up/Down button on the panel.

(20) Separation values of FHR1 curve and FHR2 curve.



FHR signal quality indicator. Red - poor signal/no signal; Yellow - signal in general; Green - good signal.

2) Uterine contraction (TOCO)

Uterine contraction value display (relative value from 0 to 100). This value has no meaning in frozen state.

(20) Uterine contraction baseline value, adjustable



3) Fetal movement (FM)



AFM: Automatic fetal movement counting, MFM: Manual fetal movement counting

③ Information

The information section is in the bottom of the screen, displaying the current status of pregnant woman and the

Monitor. From left to right: power mark, networking mark, printing mark, printing speed, pregnant woman ID, alarm volume mark, alarm information, date / time.



Power mark: When external power supply is connected, the icon  scrolls, indicating that it is charging; after fully charged, the icon changes to , which means that you are using an external power supply and the batteries are fully charged; when using the internal batteries, the icon is , indicating the battery status.

Networking mark: When connected to central station, the icon is ; when disconnected, the icon is .

Printing mark: When printing starts, the icon  is blinking; when printing stops, the icon is .

Printing speed: the current printing speed: 1cm/min, 2cm/min or 3 cm / min.

Pregnant woman ID: after started every time, the system automatically generates a serial number according to the date and time. The serial number can be changed in the monitoring process, and the changed ID is valid only for later data.

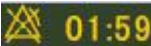
Alarm volume mark:  indicates the current alarm volume, which can be set in the menu. Press this mark to enter the alarm mute state  until a new alarm event occurs; press and hold the mark to enter the alarm pause state  01:59, and the duration is 2min. In alarm pause period, it won't alarm even if alarm event occurs.

Alarm information: When an alarm occurs, this position indicates the reason of the alarm; if the parameter limit alarm is set to ON, the option displays the parameter alarm information when alarm occurs. When the paper runs out, the door is not closed or printer malfunctions, the system will alarm and display Print Alarm Info, indicating that the printer is in a non-normal state.

Rating button : Click this button to enter rating screen.

Date / Time: Monitoring date and time; in freezing state, it displays the starting date and time of monitoring records.

4.3 Description of Menu Settings Interface

4.3.1 Main menu:

 Click for touch operation = Turning the code-wheel+ Pressing the code-wheel

Enter the main menu in the following steps:

Rotate the encoder disk, select the **parameter section** in the right of the screen and press the encoder disk to enter the Main menu interface.

The operation in this interface is simple and easy: Rotate the encoder disk, press the encoder disk to confirm when an item turns blue to enter the Settings interface, or touch a certain item to access the setting interface of this item.

The detailed parameters of the interface are as below:

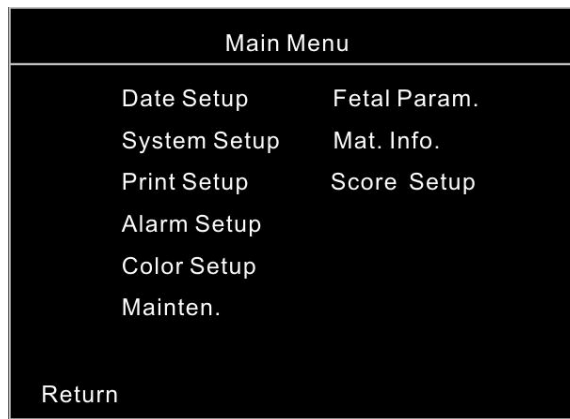

Fig. 4-3 12.1-inch Main Menu Settings Interface

Date Setup: Set the system date and time.

System Setup: Set the system parameters.

Print Setup: Set the printing parameters.

Alarm Setup: Set the parameter alarm information.

Color Setup: Set the parameter color.

Mainten.: Set the maintenance info.

Fetal Param: Set the fetus parameters.

Mat. Info: Set the relevant information of pregnant woman

Score Setup: Set the rating information.

The operation in each setting interface is as follows:

Rotate the encoder disk, when an item turns blue, press the encoder disk to confirm and pop up the adjustable parameters, then rotate the encoder disk to select, press the encoder disk to confirm, finally rotate the encoder disk to X, and press the encoder disk to exit the setting.

or

Touch a certain item to pop up the adjustable parameters of this item. Then touch the required parameter. Finally touch **【X】** to exit this item.

4.3.2 Date

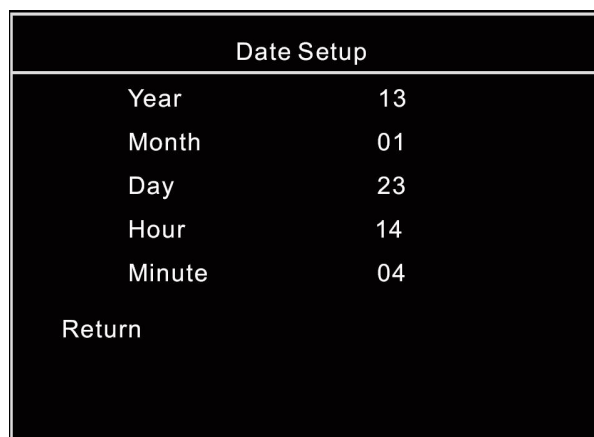

Set the system date and time (24-hour).

4.3.3 System

System Setup	
Print Length	0 min
Display Mode	MON
Display Speed	X4
Language	English
Power Off	0 min
ALM Volume	1
Factory Settings	
Return	

Print Length: Set the printing duration (up to 60min); when the print time is up, printing stops. 0 indicates that the function is invalid.

Display Mode: Select “Monitoring” or “Demonstration”. In demo mode, the curve interface displays “DEMO”.

Display Speed: Adjust curve display speed; available options are X1, X2, X4, and X8.

Language: Switch languages.

Power Off: 0 indicates that the function is disabled; other values indicate that if the time without signal exceeds the values, the system will automatically turn off. The time of automatic power off can be set up to 240min.

ALM Volume: Set the alarm volume; available options are 0, 1, 2, and 3.

Factory Settings: Press this option to restore the system to its default values.

4.3.4 Print

Print setup	
PRT Seed	3cm/min
PRT Density	4
TOCO 0 Position	59
TOCO 100 Position	330
FHR 90 Position	420
FHR 210 Position	780
Return	

PRT Speed: Adjust the printing speed; available options are 1cm/min, 2cm/min, and 3cm/min.

PRT Density: Adjust the printing density of curves to accommodate different thermal paper; available options are 1, 2, 3, 4, and 5.

The following four operations are to ensure that you can print with 152mm printing paper of different specifications:

TOCO 0 Position: Adjust the printing position of TOCO 0

TOCO 100 Position: Adjust the printing position of TOCO 100

FHR 90 Position: Adjust the printing position of FHR 90

FHR 210 Position: Adjust the printing position of FHR 210

The adjustment method is as follows:

In the printing setting interface, rotate the encoder disk to select one of the items, press the encoder disk to confirm and enter the sub-menu, and the printer starts printing four lines on the printing paper, which are UC 0, UC 100, FHR 90 and FHR 200 respectively. If a position has deviation, adjust in the sub-menu to make the positions coincide. After adjusted, click X in the top of the sub-menu to close the submenu and stop printing. This system can print with 152mm printing paper of different specifications.

4.3.5 Alarm Setup



Alarm Enable: Whether enable fetal parameter out-of-limit alarm; ON --- Enable; OFF --- Disable.

Alarm Level: Alarm priority: high, medium and low.

ALM HI_LIMIT: High limit of FHR alarm; available options are 160, 170, 180, and 190 bpm.

ALM LO_LIMIT: Lower limit of FHR alarm; available options are 90, 100, 110, and 120 bpm.

Alarm Delay: Trigger time; the time interval from the discovery of FHR out-of-limit to alarm started; available options are 15 seconds and 30 seconds; when the alarm is set to ON, an alarm sound is produced when the trigger time is up.

PRT_ALM ENABLE: Whether enable printing fault alarm; ON --- Enable; OFF --- Disable.

4.3.6 Color



Set the colors of physiological parameters in the interface.

4.3.7 Maintenance

Mainten.	
Hospital	XXXXX
FHR Range	30-240 bpm
Transducer	Wired
Net	RS485
Touch Calibration	
Version	V1.0
Return	

Hospital: Can be edited by entering the name of the hospital, which can be saved after turning off.

You can enter up to 20 characters.

FHR Range: The display range of fetal heart curve: 50-210 bpm / 30-240 bpm.

Transducer: The type of connected probe: wired and wireless.

Net: With the central station networked communications, TCP/IP, RS485 is optional.

Touch Calibration: Into the touch calibration mode.

Version: Software version number; not adjustable.

4.3.8 Fetal Param

Fetal Param.	
Twin Offset	20bpm
FM Trace	ON
FM Count	AUTO
FM Threshold	10%
FHR Channel.	FHR1
TOCO Reset	10
Return	

Twin Offset: In twins state, to avoid FHR2 curve coinciding with FHR1 curve, lower the position of FHR2 curve for several unit points, which are the curve separating values; available options are 0, 20, 30; 0 indicates no separation. Unit: bpm.

FM Trace: Display or close fetal movement curve on the interface. Fetal movement curve is a uterine contraction curve shown in TOCO area, indicating the dynamic information of fetal movement; select "ON" to display the fetal curve, or select "OFF" to hide.

FM Count: "Manual" and "Auto" are available; select "Auto", and the display shows "Automatic fetal movement" on the right of the fetal movement area; select "Manual", and the display shows "Manual fetal movement" on the right of the fetal movement area. About the "Automatic fetal movement" and "Manual fetal movement", refer to the description of fetal movement in Chapter 7.

FM Threshold: Threshold of automatic fetal movement, adjustable from 10% to 80%; fetal movement threshold indicates the percentage of fetal movement intensity; if 10% is selected, a minor fetal change is counted as a fetal movement; if 80% is selected, only strong fetal movement

will be counted; it is recommended to set to 40%~60%. If the 'fetal movement counting' is set to 'Auto', i.e. automatic fetal movement, the setting is effective.

FHR Channel: Select the channel of fetal heart tones.

TOCO Reset: Select the uterine contraction reset value; available options are 0, 05, 10, 15, and 20.

4.3.9 Pregnant Woman Info

Mat. Info.	
ID	13012401
Name	xxxxx
Gest. Week	25W
Gest. Day	0D
Parity	0
Bed ID	1
Return	

ID: ID of the pregnant women under monitoring; if it isn't set, the system will automatically generate an ID according to the date and time.

Name: Select this option to enter the name input interface, which only accepts numbers and English letters. Enter the name, which won't be saved after turning off.

Gest. Week: The weeks of gestation, which are from 25~44.

Gest. Day: The number of days after removing the number of gestational weeks: 0 ~ 6.

Parity: The times of pregnancy.

Bed ID: Set the bed when networked with the central station. Networking option R485 corresponds to 1-4; networking option TCP / IP corresponds to 1-32.

4.3.10 Rating

Score Setup	
Scoring Type	Fischer
Test Type	NST
Return	

Rating Criterion: The reference of rating; available options are Fischer and Krebs.

Type of Experiment: NST, CS-NST, OCT and CST are available.

4.4 Backing Operation:

In the menu screen, select 'Back' to return to previous menu step by step, or press the UC Reset button to return to the monitoring interface directly.

In the menu state, the system can still calculate the real time fetal heart rate and uterine contraction pressure; if the system is in real-time printing state, you can still print it in real time.

5. FHR Monitoring

Misidentifying MHR as FHR

Introduction

FHR Setting

FHR Monitoring

Common Symptoms of Fetal Monitoring

Cleaning and Maintenance

5.1 Misidentifying MHR as FHR

It does not always mean that the fetus is still alive when the Monitor detects FHR. Before monitoring, confirm that the fetus is still alive, and then confirm that the fetus is the source of recorded heart rate (see 1.1 Confirming the Fetus is Still Alive before Monitoring).

The following examples indicate how MHR is misidentified as FHR.

- **When using an ultrasonic transducer:**

△ The maternal signal source may be picked up, such as the beats of mother's heart, aorta or other large vessels.

△ When MHR is higher than normal value (especially above 100bpm), misidentification may occur.

- **When fetal movement curve (FM) is enabled:**

Keep in mind that the only the FM mark on the fetal trace does not always indicate that the fetus is still alive. For example, the FM mark still appears when the fetus is dead under the following conditions:

△ Dead fetus moves during or after the mother moves.

△ Dead fetus moves during and after artificial palpation of fetal movement (especially if the applied pressure is too large).

△ Movement of the ultrasonic sensor.

5.2 Introduction

FHR monitoring is achieved basing on the Doppler Effect. We know that a certain frequency of ultrasonic will be reflected when encountering obstacles in the transmission. If the object is stationary, the reflected wave and the transmitted wave have the same frequency. Once the object moves, the reflecting frequency will change. The reflecting frequency of the object facing the sound source becomes higher, and the reflecting frequency of the object back to the sound source becomes lower. The faster the object moves, the greater the frequency changes. This effect is called the Doppler Effect. Clinically, the ultrasonic sensor is used to emit ultrasonic waves to human body, the echo signal changes when encountering organs in motion, such as the heart, and the heart rate is derived by processing the echo signal.

Clinically, the best position for heart rate monitoring with Doppler is the fetus with its back toward the mother's abdomen. If the fetus is facing the abdomen, the hands and the feet will affect the echo, the fetal turn makes the heart deviate from the irradiation area of the probe, the echo signal will decay, and some of the Doppler components disappear.

Fetal heart probe position

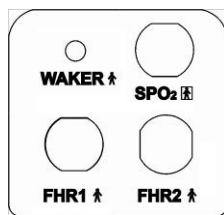

Fig. 5-1 Right Panel

The fetal heart probe is connected to the FHR1 three-in-one probe socket and FHR2 secondary probe socket in Fig. 5-1.

[Warning] Please use the accessories produced or recommended by the manufacturer.

5.3 FHR Setting

FHR settings include: Curve separation (for twins), upper alarm limit, lower alarm limit, alarm switch, alarm levels, alarm volume, fetal tone channel (for twins), etc.

[Note]

The high limit of FHR alarm is usually set to 160bpm, and the lower limit is set to 120bpm.

Please set the alarm switch to ON, so that the FHR abnormalities can be detected timely.

5.4 FHR Monitoring

FHR measurement is to obtain the fetal heart rate by the mother's abdominal wall: place the ultrasonic probe on the abdomen of pregnant woman, the sensor will emit low-energy ultrasonic signals to fetal heart and receive the echo signals from the fetal heart.

5.4.1 FHR Signal Acquisition Methods and Steps:

- 1) Find the position of strongest fetal heart with a stethoscope, or touch the fetal position and find the optimal fetal position;
- 2) Coat coupling agent evenly on the acoustic surface of the ultrasonic probe;
- 3) Place the ultrasonic probe on the maternal fetal side, move slowly and listen to the fetal heart signal until you find the clearest fetal heart signal;
- 4) Secure the ultrasonic probe with a bandage, and then adjust to make the signal is clear and the instrument can accurately count; if the fetus is in head position, the best position is usually in the left or right below the navel; if the fetus is in breech position, the best position may be above the womb;
- 5) Check if the FHR value displayed by the Monitor appears.

In the monitoring process, the Monitor always keeps the volume with fetal heart beat clearly audible. Do not completely turn off the Monitor's sound;

- 6) When there is strong fetal movement, uterine contraction or body movement of pregnant woman, the position of fetal heart may change greatly, and can't hear clear fetal heart beats. In this case, adjust the position of the ultrasonic probe to regain excellent fetal heart signals.

[Note]

The monitoring records of the best quality can be obtained only when the probe is placed in the best position.

[Warning]

Do not turn off the speaker volume during monitoring. When the FHR signal is very weak (fetal heart abnormal or fetal heart drifts to edges of probe detection zone) or there is no FHR signal (fetal heart drifts out of the probe detection zone or stillbirth), and hear rhythmic fetal heart tones are barely heard through the speaker, pay particular attention in this case. The FHR figure shown on the screen is meaningless.

5.4.2 Single Fetus Monitoring

Monitor one fetus. Identify the fetal heart position and tie the ultrasonic probe according to 5.3.1 FHR Signal Acquisition Methods and Steps.

In the monitoring process, the Monitor will display the FHR value and corresponding curve. If the FHR is greater than the upper alarm limit or lower than the lower alarm limit, the indicator on the front panel of the Monitor will change from green to red and flash. If the time of FHR out-of-limit exceeds the set alarm delay, the system will alarm if the alarm is enabled, the bottom of the screen has prompt, and the alarm icon  appears above the FHR curve; if the alarm is disabled, alarm prompt and alarm icon will not appear.

5.4.3 Twins Monitoring

Monitor twins. Identify the fetal heart position and tie the master and secondary ultrasonic probes according to 5.3.1 FHR Signal Acquisition Methods and Steps. In order to observe two FHR curves clearly, it is recommended to set the separation value of twins curve (i.e. a value other than 0).

Curve separation: In twins state, to avoid FHR2 curve coinciding with FHR1 curve, lower the position of FHR2 curve for several unit points, which are the curve separating values; available options are 0, 20, 30; 0 indicates no separation. If 20 are selected, FHR2 curve is 20BPM lower than the real curve; the FHR2 value displayed in the parameter area in the right is true value and isn't affected by the curve separation setting. Identify the sound output from the master probe (FHR1) or the secondary probe (FHR2) by setting fetal heart tone channel.

In the monitoring process, the Monitor will display two FHR values and corresponding curves. If either FHR is greater than the upper alarm limit or lower than the lower alarm limit, the indicator on the front panel of the Monitor will change from green to red (high level alarm) or yellow (medium / low level alarm) and flash. If the time of FHR out-of-limit exceeds the set alarm delay, the system will alarm if the alarm is enabled, the bottom of the screen has prompt, and the alarm icon  appears above the FHR curve; if the alarm is disabled, alarm prompt and alarm icon will not appear.

To monitor single fetus with twins monitor, please select FHR1 as the fetal tone channel, otherwise you can't hear the fetal heart tone.

5.5 Common Symptoms of Fetal Monitoring

The normal range of FHR baseline is 120~160 beats / minute (BPM), and baseline changes are those changes over 15 minutes.

(1) Fetal tachycardia:

The heart rate baseline exceeds 160BPM, and factors in relation to or resulting in tachycardia include: fetal hypoxia, maternal fever, maternal hyperthyroidism, anemia in the fetus, amnionitis; fetal tachycardia is usually accompanied by heart rate variability disappearing.

(2) Fetal bradycardia:

The heart rate baseline is lower than 120BPM.

(3) Heart rate variability:

Heart rate variability is an important feature to estimate fetal status at any given time. It reflects the integrity of the neural regulation system and cardiovascular systems of the fetal heart, including short-term and long-term variability.

Short-term variability is the irregularity between heartbeats, and is caused by the error of normal cardiac electrical activity cycle.

Long-term variability is the fluctuations of heart rate curve.

Acceleration is the periodic heart rate changes above FHR baseline, and relates to fetal movement and uterine contractions.

Deceleration is the periodic heart rate changes below FHR baseline. Unlike the baseline change, the duration of deceleration is relatively short, usually less than 10 minutes. According to the shape and the relation with uterine contraction cycle, it can be divided into the following three types:

- ① Early deceleration: The obvious feature is that FHR begins to decline before uterine contractions and returns to the baseline after uterine contractions. It is generally related to the pressure on fetal brain.
- ② Late deceleration: The obvious feature is that FHR begins to decline when uterine contraction begins, and returns to the baseline after uterine contractions. It is generally caused by fetal hypoxia.
- ③ Variable deceleration: The shape, start time and duration of FHR curve are not the same. It is the most common during childbirth, and is usually caused by umbilical cord compression.

5.6 Cleaning and Maintenance

Caution:

If possible, always comply with the specific instructions supplied with the probe. These data may be newer than the information provided in this Manual. The information provided in this chapter is intended to be general cleaning guidelines when you can't get the special cleaning methods of certain products.

If there is any deterioration or damage, please replace the cable. In this case, do not use this cable for patient monitoring.

5.6.1 Cleaning the Probe Cable

In order to maintain cable dust-free, clean it with a piece of lint-free cloth soaked in warm soapy water ($\leq 40^{\circ}\text{C}/104^{\circ}\text{F}$), diluted non-corrosive detergent or one of the following approved cleaning agents.

Recommended cleaning agents and trademarks:

Soap: mild soap

Tensides dishwasher detergents: Alconox

Ammonia: diluted ammonia $<3\%$, window cleaner

Ethanol: 70% ethanol, 70% isopropanol, 70% window cleaner

5.6.2 Cable Sterilization

In order to avoid causing long-term damage to the cable, we recommend sterilizing the cable only when it is deemed necessary according to the hospital procedure. We recommend cleaning first.

Recommended sterilization materials:

Alcohol-ethanol 70%, isopropyl alcohol 70%

Oxoethyl Clidex

5.6.3 Processing the Cable to Prevent Cross-contamination

In order to avoid causing long-term damage to the cable, we recommend sterilizing the cable only when it is deemed necessary according to the hospital procedure. We recommend cleaning first.

Caution:

Do not sterilize the cable with a pressure cooker or bleach containing sodium hypochlorite.

6. Uterine Contraction Pressure Monitoring

Introduction

UC Settings

UC Pressure Monitoring

UC Reset mark: 

6.1 Introduction

Uterine contraction pressure monitoring is to measure uterine activities by placing a TOCO transducer on the abdomen of pregnant woman.

Measure and record the relative pressure changes, as shown below.

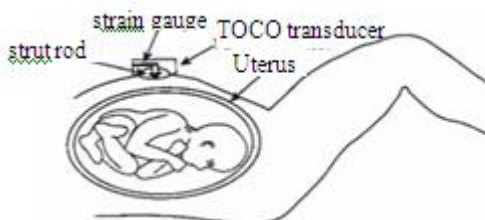

Fig. 6-1 Uterine Contraction Pressure Monitoring Diagram

UC pressure monitoring is to monitor the uterine contractions. UC pressure is the indicator of childbirth strength. Clinically, the uterine contraction has directly affected the fetal heart rate activities and childbirth. The curves recorded by pressure monitoring can provide a lot of information, such as the intensity, frequency and duration of uterine contraction, regularity and shape; the uterine contraction may cause FHR increased or reduced. At present, the FHR monitoring is accompanied by UC pressure monitoring, and the medical personnel can combine UC situation and FHR changes for diagnosis.

External pressure monitoring is to obtain UC pressure from the maternal abdomen. When a contraction occurs, the compression of the abdominal wall tension is applied on the pressure sensor, which will convert the pressure into electric signals. The resulting pressure signals are amplified and processed through the instrument, and finally output or printed.

6.2 TOCO Settings

Setting options for TOCO pressure monitoring:

TOCO Reset: Select the TOCO Reset value from 0, 5, 10, 15, and 20.

Display the contraction strength basing on selected value.

6.3 TOCO Monitoring

1. Prepare the Monitor

2. Connect the probe

Place the TOCO probe on mother's abdomen and fix with strap.

Warning:

Do not monitor patients underwater.

3. Collecting TOCO Data

The strap should have moderate elasticity. If it is too tight, the peak of uterine contraction may be flat topped and lower than 100 on the pressure gauge. If it is too loose, the probe may slip, causing abnormal readings. Adjust the strap pressure as required.

[Note]:

Do not use ultrasonic coupling agent on the UC probe or probe contact area.

4. Monitor Adjustment

Press the UC Reset button on the front panel to adjust the pressure to the reset value. Press the UC Reset button once, the main interface will show a UC reset mark, and only one press is valid if the UC Reset button is pressed repeatedly within 5 seconds.

[Note]:

Pressure adjustment must be carried out between two uterine contractions.

7. Fetal Movement Monitoring and Fetus Wake-up

Introduction

Fetal Movement Monitoring

Fetal Wake-up

Automatic fetal movement mark: ; manual fetal movement mark: ; wake-up device mark: 

7.1 Introduction

The activities of the fetus in the uterus is called fetal movement, which are shown as fetal limb movement, swing, fetal head and body rotating, turning and rolling. Fetal movement is the movement signals sent by fetus to its mother, and an objective sign of fetal life. Presence or absence of fetal movement is directly related to fetal safety, and the state of fetal movement is also an important indicator used by obstetricians to observe the fetus. Therefore, both pregnant women and obstetrician must know the fetal movement timely. Fetal movement monitoring includes automatic and manual monitoring. Automatic fetal movement monitoring is to convert the fetal movement signal into electrical signals through the sensor, amplify and process through the instrument, and then automatically record the fetal movement information obtained by the instrument. Manual fetal movement monitoring is that the pregnant woman uses the relevant accessories to mark fetal movement information according to the fetal movement during monitoring.

7.2 Fetal Movement Monitoring

This Monitor features automatic and manual fetal movement monitoring.

Setting options for fetal movement monitoring

- Fetal movement intensity curve

- Fetal movement counting mode

- Fetal movement counting threshold

See 4.3.8 Fetus Settings for specific parameter settings.

If the fetal movement counting is 'Auto', the Monitor will determine if fetal movement occurs according to the fetal movement threshold; if yes, it marks once , and the number of fetal movement increases by one.

If the fetal movement counting is 'Manual', the pregnant woman shall hold the fetal movement event marker, press the button in the top of the fetal movement event marker when feeling fetal movement; the interface displays the mark , and the number of fetal movement increases by one.

[Note]:

Fetal movement waveform and uterine contraction are displayed on the same channel.

The measurement results of automatic fetal movement monitoring may be related to the following factors: fetal movement, maternal body movement, and other external interference. Therefore, please reduce the external interference (touching pregnant woman, move monitoring bed, etc.) in monitoring, and the pregnant woman should keep quiet, so that accurate results of automatic fetal movement monitoring can be obtained.

7.3 Fetus Wake-up

Fetus wake-up is to use the fetus wake-up device to give the fetus a certain amount of stimulation and wake up the sleeping fetus. Fetus wake-up mainly applies non-stress test (NST), which can avoid misjudgment of NST results by obstetrician. NST is to observe and record fetal heart rate and uterine contraction curve without uterine contraction or other external stress; it is an ideal method to determine the function of fetal placenta.

7.3.1 Fetal Wake-up Device

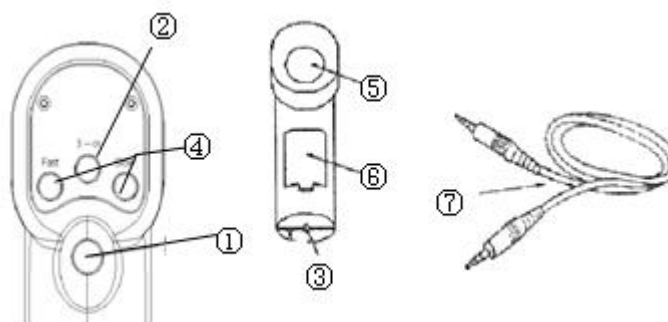

Fig. 7-1 Wake-up Device and Connecting Cable

① Power switch

Press this switch and the instrument begins operation; press it again to stop operation.

There are two modes of operation: continuous mode that operates when the switch is pressed and three-time mode that operates three times and stops in any condition.

② Mode selector switch

Continuous mode and 3-sec mode are optional.

③ Marker socket

Connect with the fetal monitor through the audio cable.

④ FAST, SLOW knob

Adjust vibration rhythm during operation (intermittent repetition period).

⑤ Vibrating head

Vibrating surface

⑥ Battery holder

Use two alkaline batteries.

⑦ Audio cable

Connect to the fetal monitor, and a message appears automatically when the vibration sound pulse occurs.

7.3.2 Preparation for Operation

(1) Turn on the fetus wake-up device, and check if the device works properly. Do not use if there is any problem;

Before using, load the batteries and close the battery compartment cover in the steps as follows:

- Remove the battery compartment cover

Insert a coin, tweezers or similar flat object in the position indicated by the arrow in the lower left to remove the battery compartment cover, and press down the battery compartment in the arrow direction (Fig. 7-2)

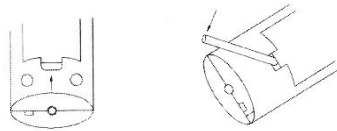

Fig. 7-2 Removing the Battery Cover

➤ Load the batteries

Load two alkaline batteries into the battery compartment according to the polarity indication on the battery compartment (battery anode and cathode matching the anode and cathode on the battery compartment) and close the battery cover, as shown in Fig. 7-3.

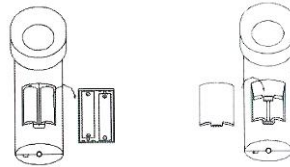

Fig. 7-3 Loading the Batteries

➤ Remove the batteries

Press down the cathode \ominus of the batteries with a finger to remove the batteries.



Caution: If the instrument won't be used for a long time, take out the batteries.

[Note]

- ① Do not mix old and new batteries or different types of batteries together;
- ② Do not disassemble the batteries to avoid battery leakage or rupture
- (2) Connect the fetus wake-up device to the interface in the rear of the fetal monitor. Connection example is shown below:

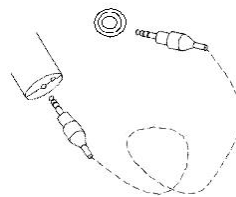

Plug one end of the audio cable to the fetus wake-up socket.

Audio cable is available in single and dual-channel versions. Fetal monitors produced by different manufacturers may require different audio cables. Two kinds of audio cables are applicable for the fetal monitor produced by our Company.

- (3) Press the Mode button to switch the wake-up device between three-time mode (stop automatically after vibrating three times) and continuous mode.

7.3.3 Waking up the Fetus

Place the vibrating head of the instrument on the mother's abdomen, press the vibration switch, and release to stop vibrating. Under normal circumstances, the vibration can awaken the fetus. When the fetus wake-up device is started, the main interface will show a mark of fetus wake-up device.

8. Alarm

Alarm is a means of prompt when the patient monitoring data and the state of the Monitor have abnormalities. The alarm category includes physiological and technical. Alarm indication means include audible alarm, warning lamp flashing and text prompt.

8.1 Alarm Category

Monitor alarms mainly refers to the physiological alarms and technical alarms. Physiological alarms are generated when the physiology of the patient is abnormal. Technical alarms are generated when the Monitor or the application part can't monitor the patient properly.

8.1.1 Physiological Alarms

Physiological parameter alarm requires the following three conditions:

- 1) Alarm switch is ON;
- 2) The parameter value is out-of-limit and the duration exceeds the set alarm delay;
- 3) Alarm occurs in the non-suspension period of alarm.

The physiological alarms of this Monitor include:

FHR1 high / low

FHR2 high / low

8.1.2 Technical Alarms

The technical alarms of this Monitor include:

- Printing abnormal alarms of the system include
Print compartment is not closed
Lack printing paper
- The abnormal state alarm of the system include
Cuff leaks air, pressure measurement timeout
- Prompt messages used by the Monitor, including "FHR coincided", "low battery", etc.

8.2 Alarm Level

Both technical alarm and physiological alarm have corresponding alarm levels, and need different medical treatment.

The physiological alarm levels of the Monitor are set to high, medium, and low, and the technical alarm level is always low.

8.3 Alarm Indication

When the Monitor alarms, there are three ways of alarm indication, audible alarm, warning lamp flashing alarm, and text alarm.



8.3.1 Audible Alarm

Audible alarm is that the Monitor automatically sends alarm sound when the alarm occurs. According to the alarm levels, audible alarms are divided into three types.

- High level audible alarm is 'beep, beep, beep - beep, beep'
- Intermediate level audible alarm is 'beep, beep, beep'
- Low level audible alarm is 'beep, beep'

Note

When different levels of alarms occur simultaneously, the alarm sound is the highest level audible alarm.

Press and hold the  button to pause alarm. Press the  button to enable alarm mute / reset function.

Alarm mute / reset function is achieved by controlling the alarm sound; while the warning lamp flashing alarm and text alarm are not controlled.

8.3.2 Warning Lamps Flashing Alarm

Warning lamp flashing alarm is that the alarm indicator of the Monitor changes automatically when alarm occurs.

Alarm indicator: Flashing red ---- High level alarm

Flashing yellow ---- Intermediate level alarm

Constant yellow ---- Low level alarm

Note

When different levels of alarms occur simultaneously, the alarm indicator is the highest level alarm indication.

8.3.3 Text Alarm

When the Monitor has abnormal condition alarm, the bottom of the screen displays the text prompt.

Text alarms include:

- FHR1 high / low, FHR2 high / low,
- Printer compartment is not closed, lack printing paper, FHR coincided, and low battery.

Table 8-1 Default Alarm Limits of Parameters

Type	Default Alarm Levels	Lower Range	High Range	Default Alarm Limit Range	Step
FHR	Med	90-120	160-190	120-160	10

9. Printing

- Installing Printing Paper
- Print Settings
- Print
- Cleaning the Printing Head

9.1 Installing Printing Paper



Picture 9-1 Slot of Printer

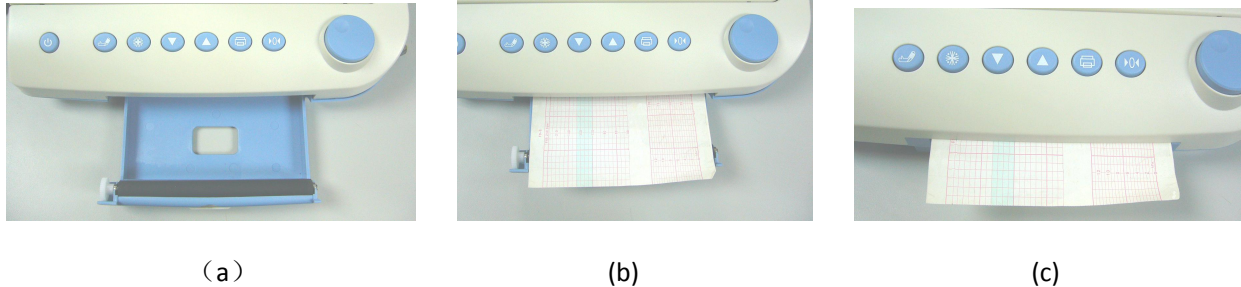

Picture 9-2 Install the printer paper

Steps to install printer paper:

1. Open the printer slot, spread the uppermost page of printer paper from outside (close to the machine) to inside (close to the user) as picture 9-2(a), then you will see the thermosensitive grid on it, grid of FHR is on the left, grid of TOCO is on the right, (if opposite order, spread from inside to outside, the place of FHR and TOCO will be opposite, and it is wrong operation), and then put the pack of paper inside as picture 9-2(b).
2. Pull out a small length of printer paper, make sure both sides of it are kept in line with the printer two slots as picture 9-2(c).
3. Close the printer door lightly.

CAUTION]

If the printer mechanism is not closed well or no printer paper inside, the monitor will alarm, and will have the following tips in the information area.

AL_COVER: Printer panel not closed or not closed completely.

AL_PAPER: out of paper

9.2 Print Settings

Rotate the encoder disk, and press the encoder disk to enter the System Parameters interface for print settings:

Print Speed: Adjust the print speed to 1cm/min, 2cm/min, or 3cm/min

Print Density: Adjust the density of print curves to 1, 2, 3, 4, or 5.

The following four operations are to ensure that you can use different sizes of 152mm paper for printing:

Adjust the printing position of TOCO 0

Adjust the printing position of TOCO 100

Adjust the printing position of FHR 90

Adjust the printing position of FHR 210

The adjustment method is as follows:

In System Parameters interface, rotate the encoder disk to select any one of the above four options, press the encoder disk to enter the adjustable state, and the printer starts printing four lines on the printing paper, which are TOCO 0, TOCO 100, FHR 90 and FHR 210 respectively. If any position has deviation, rotate the encoder disk to adjust when the option is in adjustable state so that the position coincides. After adjusted, press the encoder disk to stop printing.

9.3 Print

To print, press the Print button once. When the printer is working, the bottom of the screen dynamically displays the Printing icon, indicating that the printing has started. Press the Print key again to stop printing. In frozen state, all the displayed data of the pregnant woman can be printed.

Clearing jams

If the sound of recorder running and output of the recording paper are abnormal, open the door of the recorder and check paper jams. To clear the jam:

1. Open the printer compartment door;
2. Take out the jammed paper in the printer;
3. Pull out the printing paper for a small fraction, and ensure that both sides of the paper and both sides of the compartment door are substantially parallel;
4. Gently close the printer compartment door.

9.4 Cleaning the Printing Head

The time between failures of thermal print head of this Monitor is more than 20 years. This is only the electrical guarantee. The printing paper and operating environment cleanliness have great influence on the printing. If the print is not clear or some areas can't be printed, clean the print head in the methods and steps as follows:

1. Turn off the Monitor.
2. Open the printer panel.
3. Insert a cotton swab dipped in anhydrous ethanol onto the thermosensitive element of the print head (visible thin black thermal tape on the print head), move around and wipe gently, especially in the area of unclear printing, and turn on the instrument after a few minutes.
4. If the problem is not completely eliminated, repeat step 3.

10. Rating

Description

Operation

Alarm

10.1 Description

Turn the code-wheel in the monitoring mode, select “”, and press the code-wheel to confirm to access the rating mode.

Or

Just touch  to access the rating mode.

Red border—The option is chosen.

Green border—The option is adjustable.

The duration between two neighboring time marks is 5 minutes.

The minimal time duration to be rated and analyzed is 10 minutes and the maximal time duration is 34 minutes.

The selection of channels for rating fetal hearts

Data of only one fetal heart can be rated at a time. When pregnant woman numbers are changed, the selection of fetal hearts will restore to its default value.

The principle follows:

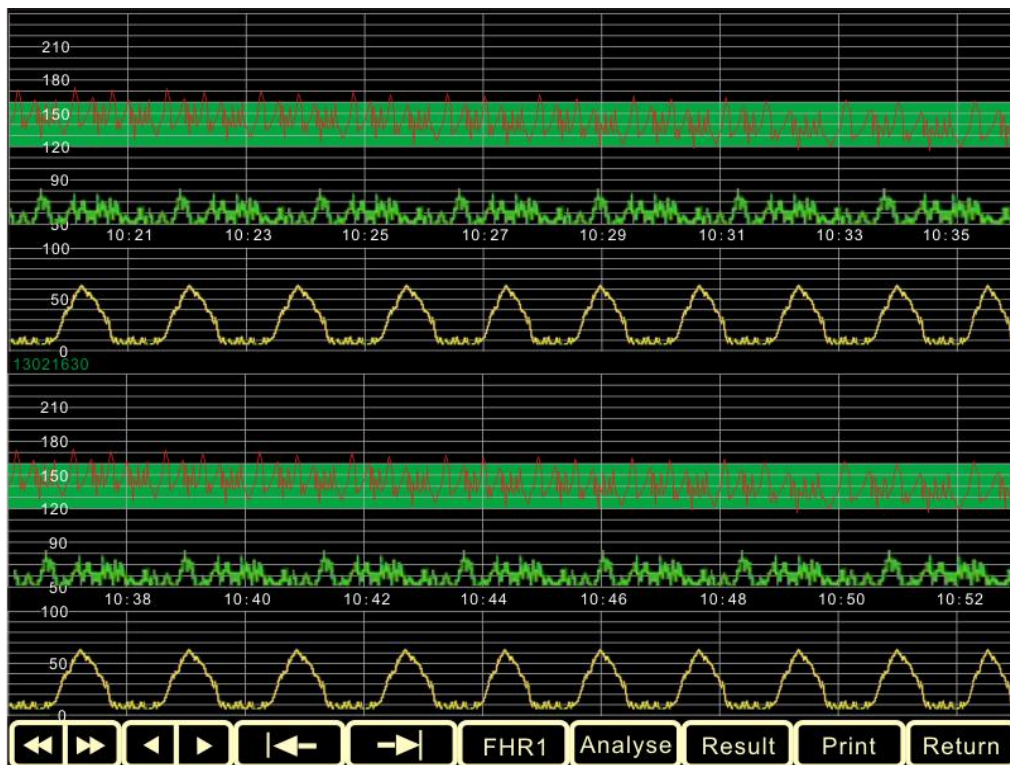

Select FHR with data by default; if both FHR1 and FHR2 have or do not have data, the default is FHR1



10.2 Operation



(1) : Select record; view the monitoring records of different pregnant woman IDs.

Method of operation: Rotate the encoder disk to select the icon, press the encoder disk to confirm, and then select the records. Rotate the encoder disk counterclockwise to switch to previous ID, rotate the encoder disk clockwise to switch to next ID, and finally press the encoder disk to confirm; the operation is completed;

Method of touching operation: Click , and you will turn forward to a pregnant woman number. Click , and you will turn backward to a pregnant woman number.



(2) : Select area; select the monitoring records of the same ID so that the rating area is shown on the display.

Method of operation: Rotate the encoder disk to select the icon, press the encoder disk to confirm, and then adjust the waveform; rotate the encoder disk counterclockwise to switch to previous five minutes of data, rotate the encoder disk clockwise to switch to next five minutes of data, and finally press the encoder disk to confirm; the operation is completed;

Method of touching operation: Click , and you will turn 5-minute data forward. Click , and you will turn 5-minute data backward.

(3) : Select the starting point, and adjust the starting point of the data to be rated.

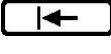
Method of operation: Rotate the encoder disk to select the icon, press the encoder disk to confirm, and then the starting scale of the rating data changes from blue to red; move the encoder disk in different directions to move the starting scale of rating data, select the appropriate position, press the encoder disk to confirm, the scale becomes blue and the icon turns red; the operation is completed;

Method of touching operation: Click , and now the starting scale of data to be rated turns from blue to red. Click the waveform area, and move the scale to the position you click. Click  again to quit the operation.

(4) : End point selection, to adjust the end point of data to be rated. The operation method is the same as (3). While operations of (3) and (4) are being performed, all the other buttons are non-operable.

(5) : Select FHR waveform.

Method of operating the code-wheel: Turn the code-wheel, choose the icon, press the code-wheel to confirm, and it will change over to FHR2. Confirm again, and it will change over to FHR1.

Method of touching operation: Click the icon, and it will change over to FHR2. Click again, and it will change over to FHR1.

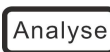
(6) : Analyze the selected data, and mark the results on the corresponding position of the

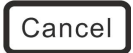

waveform.

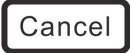
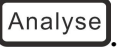

Method of operating the code-wheel: Turn the code-wheel, choose the icon, press the code-wheel to confirm, and the analysis result will be displayed. The icon changes over to .

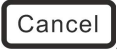
Click again, and the analysis result will be cleared. The icon changes over to .

Method of touching operation: Click the icon, and the analysis result will be displayed. The icon changes over to . Click again, and the analysis result will be cleared. The icon changes over to .

(7) : Click the icon, and the rating result will be displayed in a tabular form. Meanwhile, the icon will change over to . Click again, and the form of rating result will be cleared.

Method of operating the code-wheel: Turn the code-wheel, choose the icon, press the code-wheel to confirm, and the rating result will be displayed in a tabular form. Meanwhile, the icon will change over to . Press the code-wheel to confirm again, and the icon will change over to  and the rating result will be cleared.

Method of touching operation: Click the icon, and the rating result will be displayed in a tabular form. Meanwhile, the icon will change over to . Click again, and the icon will change over to  and the rating result will be cleared.

(8) : Click on this icon to print out the currently selected waveform and rating results table; if "Analyze" or "Rating Results" operation has been carried out, the printed waveform will have analysis remark, and the rating results table has the rating points; if no operation is performed, rating result will not appear, and the rating table is blank;

(9) : Click on this icon to exit the rating mode and return to the monitoring mode.

[Note]

- The operations of icons (1) - (5) are to select waveform, which are primary operations; other operations can be performed after these operations;
- The operations of icons (6) and (7) are the scoring process and result display, which are secondary operations. If one or more operations are performed, but aren't canceled, only option (6), (7) and (8) are available;
- Operation (8) (Print) is effective in both primary operation and secondary operation; The difference is that primary operation can't print the results, while secondary operation can print the results;

- Operation (9) returns to monitoring mode, and is primary operation;
- Before entering the scoring mode, select the scoring criteria (FISCHER and KREBS) in the System Settings.

10.3 Alarm

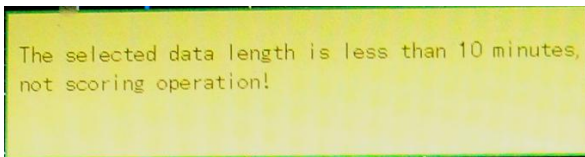

The selected data length is less than 10 minutes,
not scoring operation!

If the monitoring data length of currently selected pregnant woman ID is less than 10 minutes, the display shows prompt box, and only two operations are available, i.e. scrolling pregnant woman ID, exiting rating and returning to monitoring mode;

If the current data length is longer than 10 minutes, other operations can be performed. If the time length between two scales is less than 10 minutes when adjusting the rating data starting scale and ending scale, the system will prompt data too short, and the rating data can't be shortened any more.

Appendix 1: Troubleshooting

The Monitor has high quality and reliability. If there is any problem, please check and eliminate the problem according to the table below.

Failure	Possible Reason	Solution
No display when unit switched on.	Power cable poorly connected. Power failure, power plug or socket badly connected.	Check adapter and power cable.
Abnormal FHR value	Transducer poorly connected with instrument. Fetal heart not found, the place of transducer is incorrect. No gel or little gel. Fetal/maternal activity. The transducer is broken.	Re-connect. Re-adjust the ultrasound transducer. Add gel. Re-adjust the ultrasound transducer when signal recovered. Replace the ultrasound transducer.
Abnormal TOCO value	Transducer poorly connected with instrument. The place of transducer place is incorrect. No pressure reset No contraction	Re-connect the ultrasound transducer. Re-adjust the ultrasound transducer. Reset the TOCO value. Waiting the contractions appears.
Press the TOCO transducer, the TOCO value does not change or changes a little only.	The initial output value should be re-adjusted. TOCO transducer broken	Re-adjust the inner potentiometer inside the transducer. Replace the TOCO transducer.
Press the marker, no icon is displayed and printed	Bad marker.	Check with a multimeter and confirm.
No sound from speaker	Volume is too low	Increase the volume
Printer is working, but no FHR curve, TOCO curve on paper, or the FHR curve and TOCO curve is not in right area.	The paper is inversely installed. Or right side and left side is inverted.	Re-load the paper with the thermal side facing the printer head.
Print unclearly or some parts can't be printed out	Light printing deepness Unqualified paper Dirty printer head.	Adjust the printer deepness. Replace the paper. Clean the printer head.
Paper goes with alias Printing data position error	Paper is not loaded at its place. Using other brand printer paper Printing position is not calibrated.	Reload the paper. Replace with qualified paper. Re-adjust the printing data position according to this manual.
Rating table isn't printed	Rating switch is off	Enter Maintenance setting, and turn the rating switch to ON

Appendix 2: Specifications

Product name: Fetus / Pregnant Women/ Patient Multi-parameter Monitor

Power supply: AC 100-240V, 50/60Hz

Power consumption: < 45 VA

Battery: 14.8V lithium battery

Charging mode: Connect the Monitor to AC power and battery charging is started automatically

Discharge protection: In battery-powered mode, the Monitor will automatically turn off when the battery nearly runs out.

Fetal Heart Rate:

Transducer: Multi-crystals, Wide beam, pulsed doppler, high sensitivity.

Strength: <5mW/cm²

Working frequency: 1.0MHz

Signal processing: special digital signal.

Measurement range: 50~210 bpm/30-240bpm

Alarm Range:

High limit: 160,170,180,190 bpm

Lower limit: 90,100,110,120 bpm

Maximum audio output: 1.5 W

TOCO:

Measurement range: 0~100 units

Display:

The LCD displays FHR, TOCO, FM, time, date, volume and so on, it support freeze and review monitor data.

Resolution: 800x600

Dimension: 350 x 320 x 85 (mm) (L X W X H)

Net weight: 3.5kg

Environment

Working environment: Temperature: -10°C ~ +55°C ; Humidity: < 93%

Atmospheric pressure: 86kPa ~ 106kPa

Transport and storage temperature: Temperature: -10°C ~ +55°C ; Humidity: < 93%

Atmospheric pressure: 86kPa ~ 106kPa

Probe acoustic output: In accordance with the provisions of 1992 IEC1157, negative peak sound pressure shouldn't exceed 1 MPa, and the beam intensity shouldn't exceed 20mW/cm². Spatial peak instantaneous average intensity density shouldn't exceed 100mW/cm². The sound intensity of this model does not exceed 5mW/cm². Sound output meets the conditions exempted from publication.

Coupling agent (GEL): Viscous water-based compound, no skin irritation or allergy, chemically stable, bacteriostatic.

Accessories



Three-in-one probe
FHR probe
Uterine contraction pressure probe
Fetal movement mark button



FHR secondary probe: for twins



Fetal wake-up device



Insurance tube



Power cord



Thermal printing paper

To protect your rights of repair service, please take a few minutes to fill out the Warranty Card as follows:



Warranty Card

Product Name		
Product Type		
No.		
Date of Purchase		
Warranty Period		
Client Information	Name	
	Telephone	
	Fax	
	Address	
Sources of information	<input type="checkbox"/> Internet <input type="checkbox"/> Exhibition <input type="checkbox"/> Magazine <input type="checkbox"/> Recommended by salesman <input type="checkbox"/> Other _____	
Assessment		

